

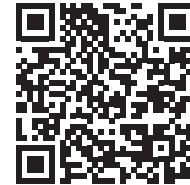



Watch the video!
Guarda il video!





GAMMAFIX[®]

by MEDESYS[®]

The revolutionary GAMMAFIX trays are characterized by excellent quality and functionality features, specifically conceived to facilitate the cleaning and sterilization process. Their special shape ensures a fully safe handling of the surgical instruments during the washing and sterilization phase, considerably reducing the risk of accidental injuries for the user. Thanks to the GAMMAFIX trays you can reduce the preparation time as you can organize them in handy and practical set-ups including the different items for each specific dental treatment. The range consists of 5 modular models, studied to offer the best versatility and efficiency. The type of silicone we selected for our trays meets the approval of the strictest Food & Drug standards (FDA).

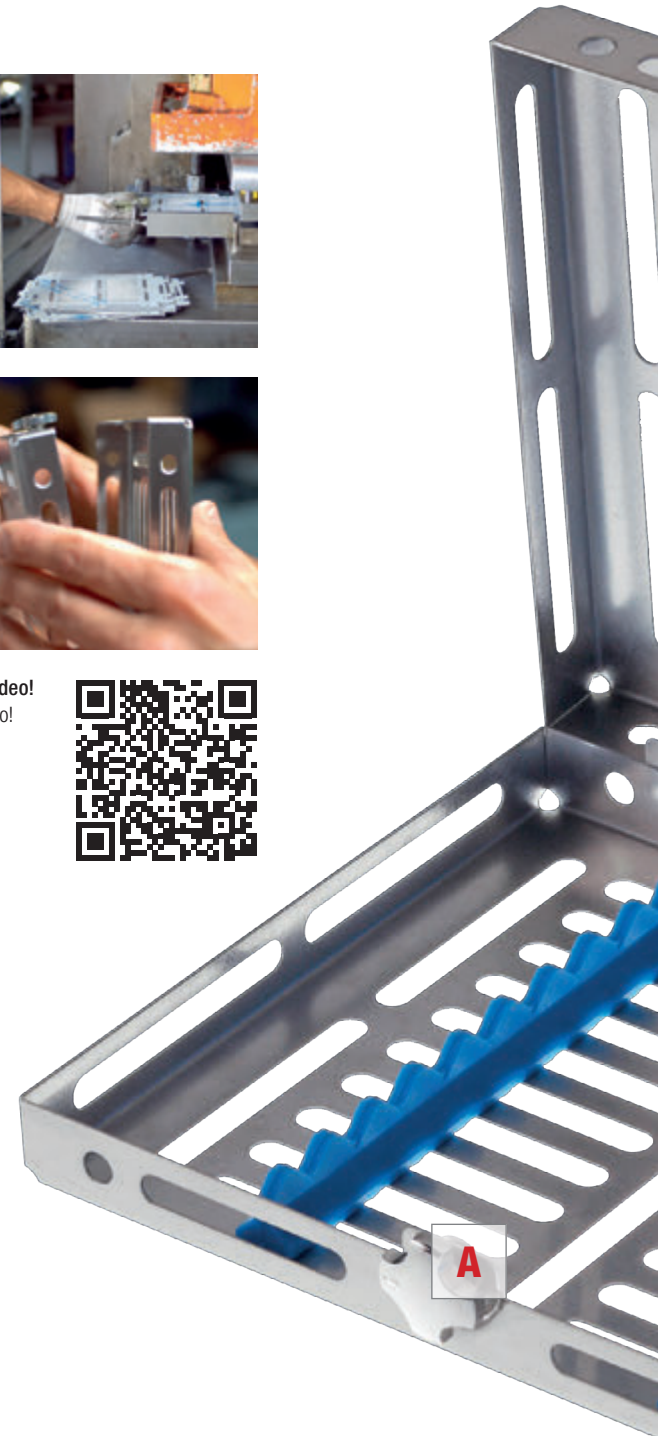
I rivoluzionari vassoi della linea GAMMAFIX si caratterizzano per l'alta qualità e funzionalità, specificatamente studiati per facilitare il processo di pulizia e sterilizzazione. La loro speciale forma permette di maneggiare lo strumentario chirurgico in massima sicurezza, anche durante le procedure di disinfezione e sterilizzazione, riducendo considerevolmente il rischio di ferite accidentali per l'utilizzatore. Grazie ai vassoi GAMMAFIX si riesce a limitare il tempo di preparazione, in quanto gli strumenti necessari per ogni attività odontoiatrica potranno essere riposti in pratici sets pronti all'uso. La gamma si articola in 5 modelli modulari, studiati al fine di offrire la massima versatilità. Il tipo di silicone prescelto è conforme ai severi requisiti Food & Drug (FDA).



A

A The exclusive locking system, keeps the tray perfectly closed. The mark on the locking knob shows the open / close position.

L'esclusivo ed efficace sistema di chiusura. La fresatura indica la posizione di apertura / chiusura.

B Open corners facilitate the outflow of residuals and water, reduce the drying time.

Angoli aperti agevolano l'uscita di acqua e residui, riducendo i tempi di asciugatura.

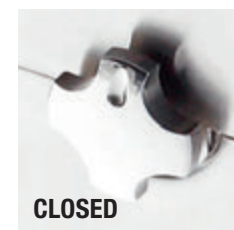

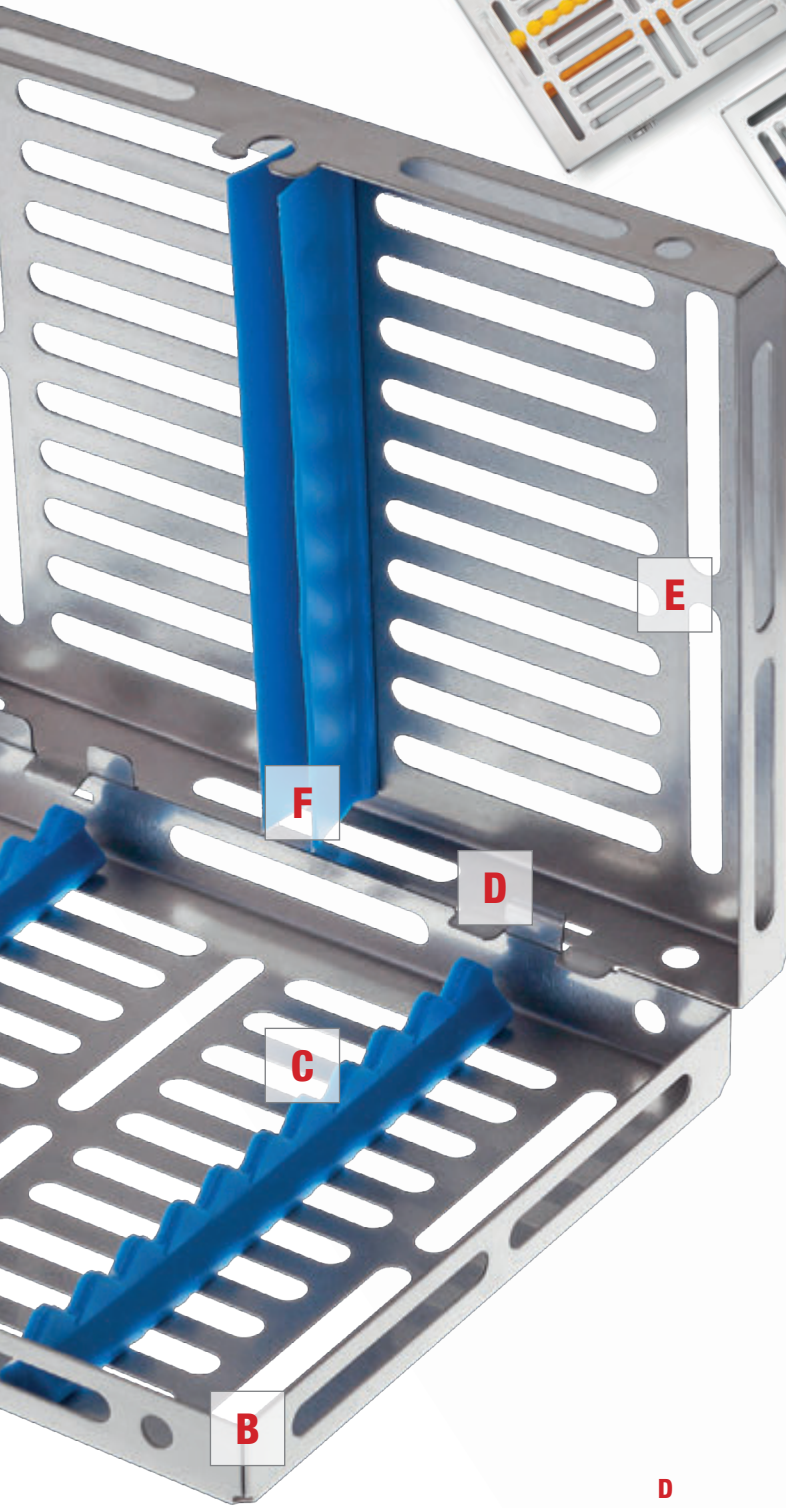

C
The type of silicone we use for our trays meets the approval of the strictest Food & Drug standards (FDA).
Il silicone utilizzato rispetta la severa normativa Food & Drug (FDA).



D
A safe and easy joint system.
Sicuro e semplice meccanismo di chiusura.

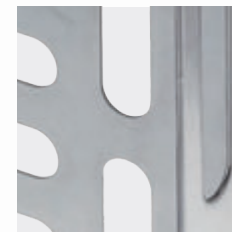

E
The enlarged holes offer more open space for a perfect washing process and a safe sterilization.
I fori di dimensione maggiore assicurano una maggiore capacità di lavaggio ed una efficace sterilizzazione.

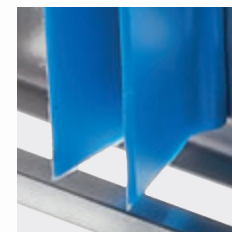

F
Improved top flexible V-Shape for the silicone profile, specifically conceived for storing instruments having different sizes.
Barretta in silicone forma V migliorata, concepita per trattenere strumenti di sezioni diverse.



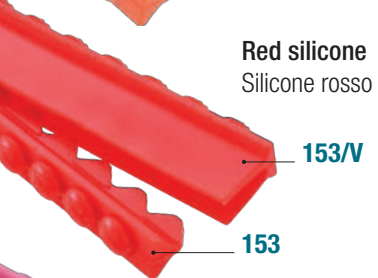
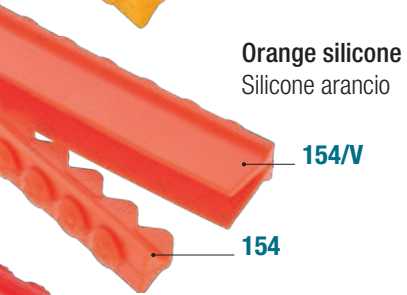
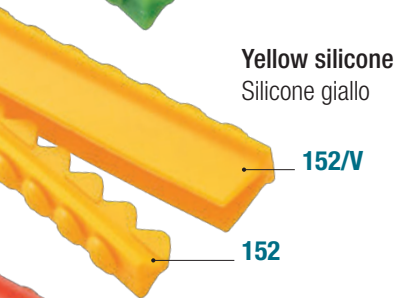
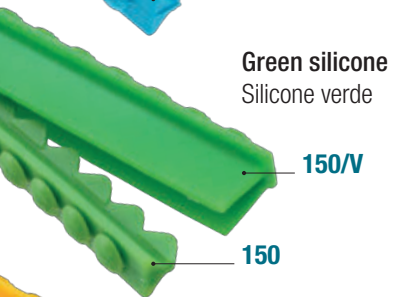
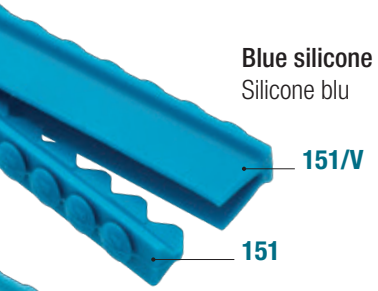

978 (UN)

978/VE with green silicone
978/BL with blue silicone
978/GI with yellow silicone
978/RO with red silicone

978/AR with orange silicone
978/RA with pink silicone
978/AZ with light blue silicone

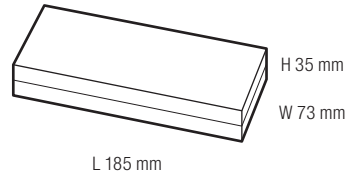

980/9 (DOI)

980/9-VE with green silicone
980/9-BL with blue silicone
980/9-GI with yellow silicone
980/9-RO with red silicone

980/9-AR with orange silicone
980/9-RA with pink silicone
980/9-AZ with light blue silicone

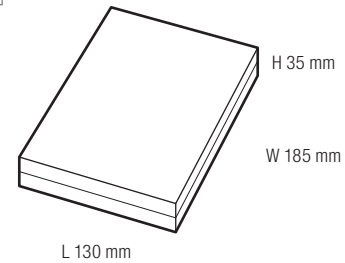

980/10 (TRE)

980/10-VE with green silicone
980/10-BL with blue silicone
980/10-GI with yellow silicone
980/10-RO with red silicone

980/10-AR with orange silicone
980/10-RA with pink silicone
980/10-AZ with light blue silicone

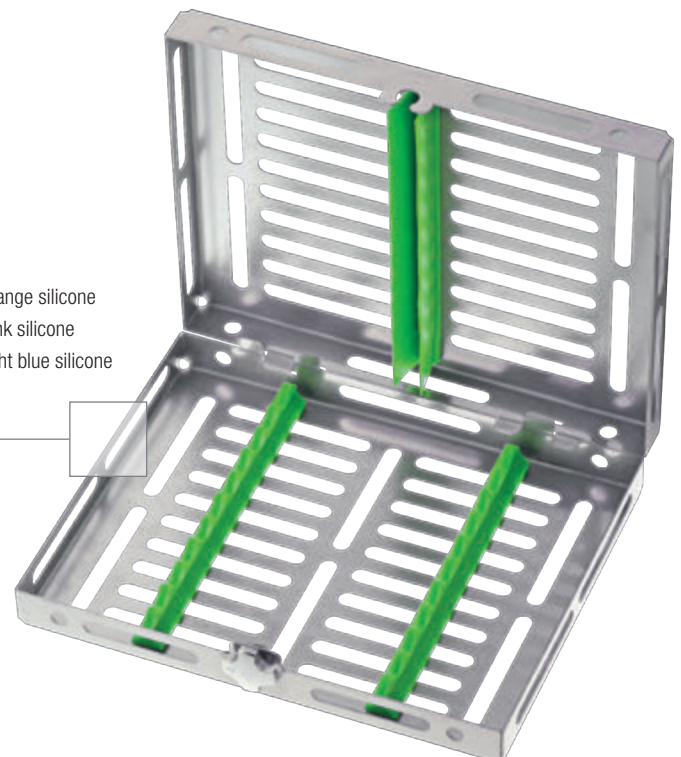
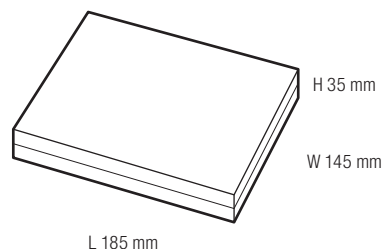



981/19 (QUATRI)

- 981/19-VE** with green silicone
- 981/19-BL** with blue silicone
- 981/19-GI** with yellow silicone
- 981/19-RO** with red silicone
- 981/19-AR** with orange silicone
- 981/19-RA** with pink silicone
- 981/19-AZ** with light blue silicone

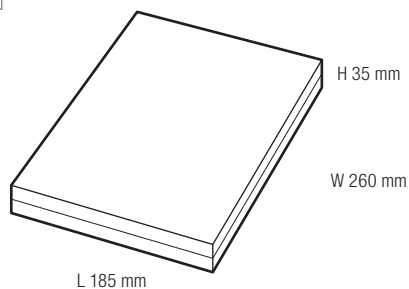

981/20 (CINC)

- 981/20-VE** with green silicone
- 981/20-BL** with blue silicone
- 981/20-GI** with yellow silicone
- 981/20-RO** with red silicone
- 981/20-AR** with orange silicone
- 981/20-RA** with pink silicone
- 981/20-AZ** with light blue silicone

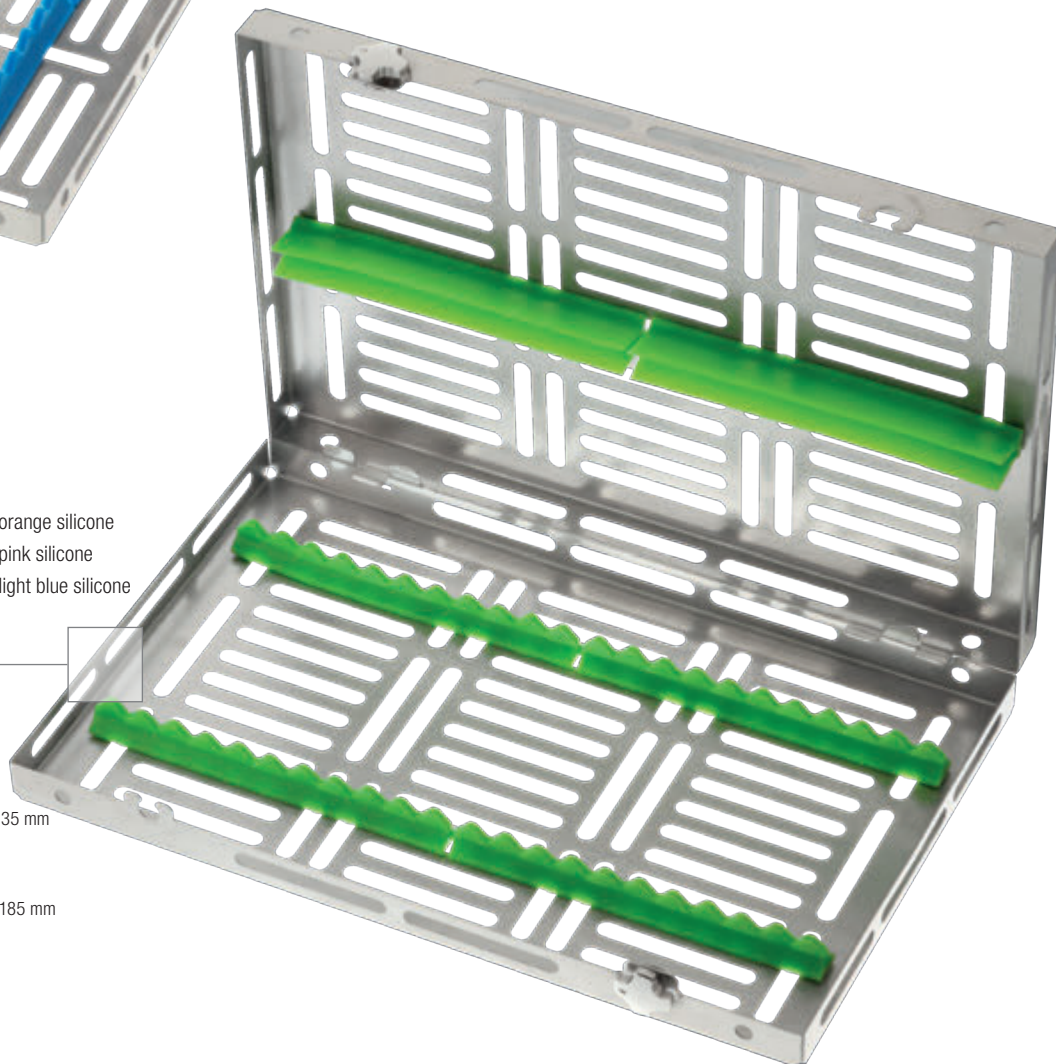
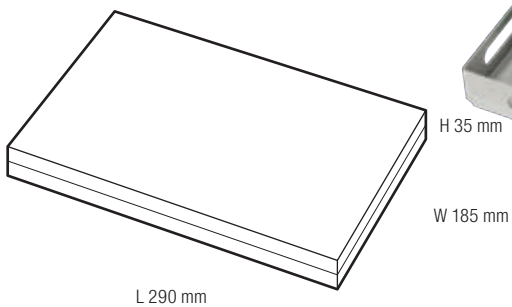

CONTAINERS



962
300 × 190 × 40 mm



963
300 × 190 × 65 mm



964
300 × 190 × 130 mm

Medesy new containers: both tray and lid are perforated to facilitate all type of sterilization; all made in aluminium, which offer special versatility a low weight, characteristic. The containers are supplied with a filter and may be used to hold sterile instruments as well as contaminated tools prior to sterilization.

I nuovi container Medesy sono perforati sia sul coperchio sia sulla base per agevolare tutti i tipi di sterilizzazione; abbiamo scelto di produrli in alluminio in quanto miglior compromesso in termini di peso e versatilità. I container sono utili sia per contenere strumenti sterili sia per riporre strumenti contaminati. I container vengono forniti già con un filtro.

963/F
Disposable paper filter, pack of 100 pcs
Filtri di ricambio monouso, confezione da 100 pz

Safe locking system
Sicuro sistema di chiusura

Anti-slipage pin
Perno antiscivolo



STERILIZATION DRUMS

CESTELLI PER STERILIZZAZIONE



1004/0
 ø mm 190 × 165
Drum inox N. 0
 Cestello inox N. 0



1004/1
 ø mm 150 × 150
Drum inox N. 1
 Cestello inox N. 1



1004/2
 ø mm 125 × 125
Drum inox N. 2
 Cestello inox N. 2

Cylindrical dressing drum sterilizers in stainless steel, with sliding strips and locking mechanism with hinges. Available in 3 diameter sizes from 125 mm to 190 mm.

Cestelli cilindrici per sterilizzazione in acciaio inox, con fasce scorrevoli e chiusura a cerniera. Sono disponibili in 3 misure, da 125 mm a 190 mm di diametro.

TRAY AND HOLDER

VASSOIO E PORTA STRUMENTI

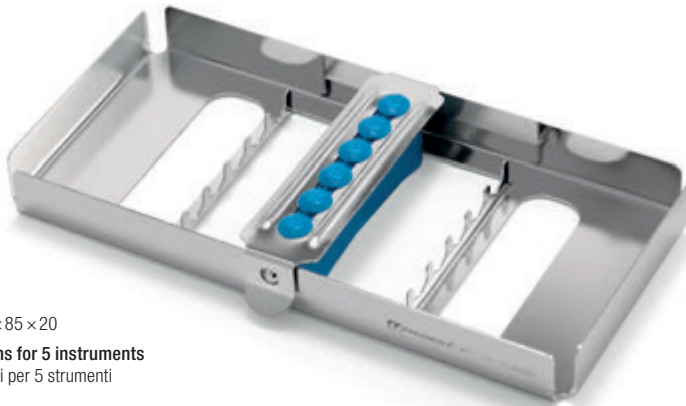

977
 mm 185 × 85 × 20
5 positions for 5 instruments
 5 posizioni per 5 strumenti

1660/1
 mm 70 × 130
Instrument holder
 Porta strumenti



INSTRUMENTS SEIZING AND STERILIZING FORCEPS

PINZETTE COGLI/TRATTIENI

Specific tweezers conceived to ensure a safe handle of surgical instruments during cleaning and disinfection procedures. The tweezers code 1011 allow you to secure the protective cap on the used syringe needles avoiding the risk of injury and infection.

Pinze sviluppate per maneggiare gli strumenti chirurgici durante la fase di pulizia e disinfezione in tutta sicurezza. Inoltre con la pinzetta 1011 è possibile chiudere il cappuccio protettivo degli aghi usati delle siringhe evitando così il rischio di ferite ed infezioni.

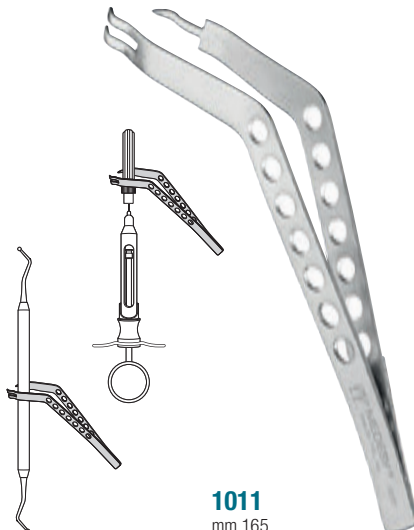

1011
 mm 165

1640 (mm 200)
1641 (mm 300)



1642
 Cheatle
 mm 270





957/2
mm 75 × 54 × 60
15 holes
15 posizioni



957/5
mm 195 × 90 × 35



957/6
mm 260 × 160 × 24
10 positions
10 posizioni

Our polysulfone trays are made of the best engineered polymers which grant excellent thermal and mechanical resistance. The trays have no sharp edges, facilitating cleaning and sanitizing procedures as well as ensuring safe transportation and handling of the surgical products. The trays are autoclavable up to 134°C / 273°F.

I nostri vassoi in polysulfone sono prodotti con i migliori polimeri, i quali garantiscono una eccellente resistenza termica e torsione meccanica. I vassoi hanno gli angoli smussi, i quali facilitano le procedure di pulizia in tutta sicurezza, anche durante il trasporto dello strumentario chirurgico. I vassoi sono autoclavabili fino a 134°C / 273°F.



957/7
mm 260 × 160 × 60

Double deck
Doppio ripiano

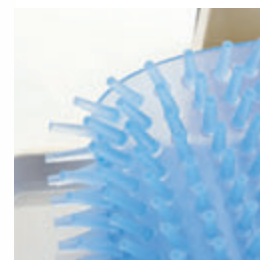

Silicon mat
Tappeto in silicone

979/BL (Blue – Blu)
979/G (Green – Verde)
979/R (Red – Rosso)
979/W (White – Bianco)

mm 190 × 90 × 25

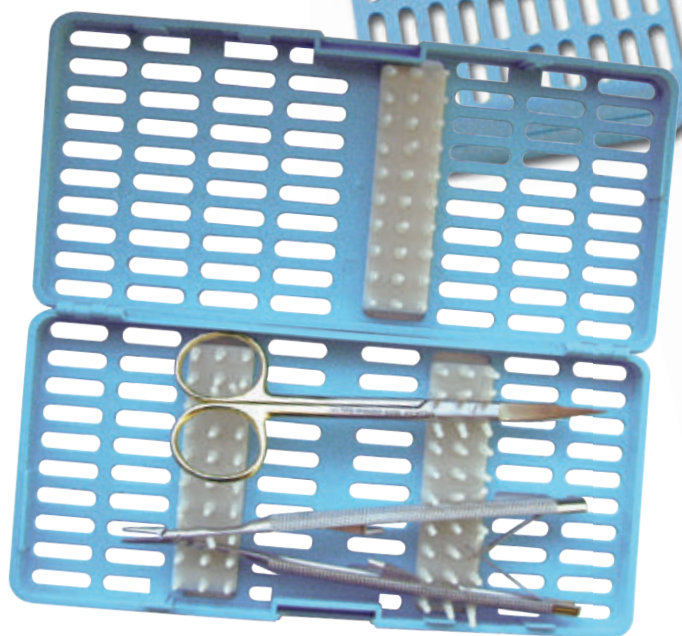

Cassette made of plastic, extremely light and versatile, equipped with 3 silicone soft mats to contain various instruments. Available in 4 different colours the cassette offers an optimal solution for rinsing and sterilizing dental and surgical tools.

Cassetta in plastica molto leggera e versatile, dotata di 3 supporti in silicone morbido contenitivo. Risulta adatta alle fasi di lavaggio e sterilizzazione per lo strumentario odontoiatrico e chirurgico. Disponibile in 4 colori.





1002/1
mm 210 × 100 × 30
Capacity / Capacità: 0,4 litre
Kidney bowls
Bacinella reniforme



1002/2
mm 280 × 150 × 40
Capacity / Capacità: 1 litre
Kidney bowls
Bacinella reniforme



1165
mm 230 × 155 × 50
Capacity / Capacità: 0,9 litre



1160
mm 310 × 195 × 55
Capacity / Capacità: 2 litre



1155
mm 220 × 165 × 20
Capacity / Capacità: 0,4 litre

LARGE / GRANDE

mm 290 × 190 × 30



1000/V

Tray
Vassoio

1001/C

Lid
Coperchio

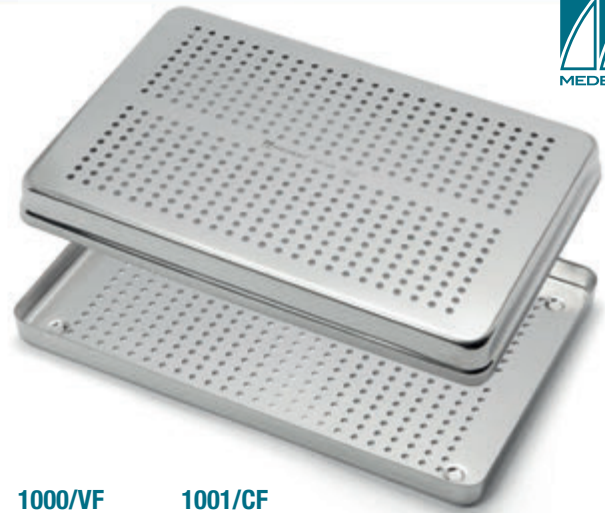

1000/VF

Perforated tray
Vassoio forato

1001/CF

Perforated lid
Coperchio forato

SMALL / PICCOLO

mm 190 × 145 × 25

1005/C

Lid
Coperchio



1005/V

Tray
Vassoio

1005/FC

Perforated lid
Coperchio forato



1005/FV

Perforated tray
Vassoio forato

RACK / RASTRELLIERE

FOR LARGE LID
PER VASSOIO GRANDE

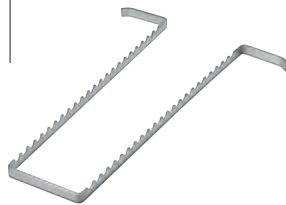

984

23 positions

Stainless steel
Acciaio inox

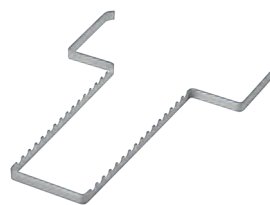

984/A

17 positions

Aluminium
Alluminio

983

16 positions

Stainless steel
Acciaio inox

983/A

11 positions

Aluminium
Alluminio



FOR SMALL LID
PER VASSOIO PICCOLO



982

8 positions

Stainless steel
Acciaio inox

982/A

8 positions

Aluminium
Alluminio



REGULAR

Tray / Vassoio: mm 285 × 185 × 15
Lid / Coperchio: mm 290 × 190 × 30

Lid
Coperchio

999/A
Silver / Argento
Regular



998/A
Silver / Argento
Regular



998/B
Blue / Blu
Regular



998/R
Red / Rosso
Regular



998/D
Golden / Dorato
Regular



998/V
Green / Verde
Regular

PERFORATED / FORATI

Lid
Coperchio

999/FG
Silver / Argento
Regular

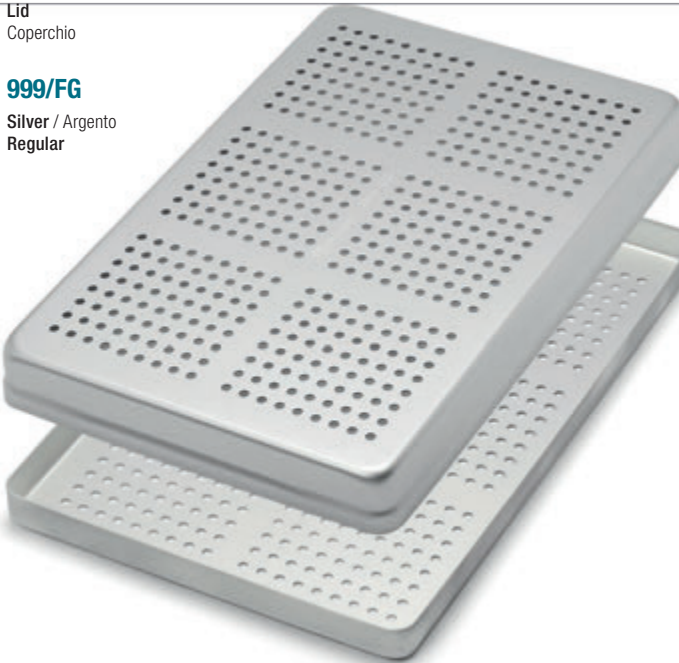

998/FA
Silver / Argento
Regular



998/FB
Blue / Blu
Regular



998/FR
Red / Rosso
Regular

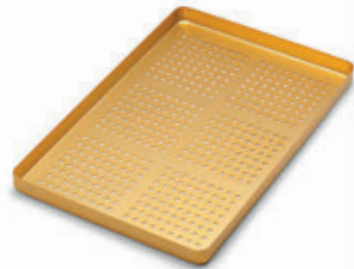

998/FD
Golden / Dorato
Regular

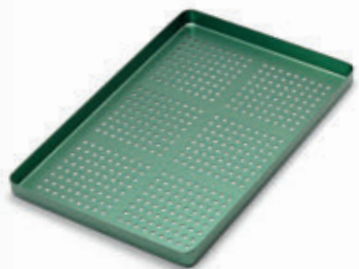

998/FV
Green / Verde
Regular

SMALL

Tray / Vassoio: mm 185 × 140 × 15
Lid / Coperchio: mm 190 × 145 × 25



Lid
Coperchio

999/AS

Silver / Argento
Small



998/AS

Silver / Argento
Small



998/BS

Blue / Blu
Small



998/RS

Red / Rosso
Small



998/DS

Golden / Dorato
Small



998/VS

Green / Verde
Small

PERFORATED / FORATI

Lid
Coperchio

999/FGS

Silver / Argento
Small



998/FAS

Silver / Argento
Small



998/FBS

Blue / Blu
Small



998/FRS

Red / Rosso
Small



998/FDS

Golden / Dorato
Small

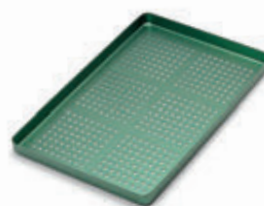

998/FVS

Green / Verde
Small



1150

ø mm 40 inox



1152

ø mm 85 inox

Capacity / Capacità: 0,1 litre



1151

ø mm 65 inox

Capacity / Capacità: 0,05 litre



1149

ø mm 25 inox

Cup with finger holder
Tazza con poggia dito

1148

ø max mm 45

Cup graduated
Tazza con scala graduata



6300

mm 150 x 80 x 15

Mixing glass
Piastra vetro per impasti



215/1 (ø mm 100 – Capacity / Capacità: 0,3 litre)

215/2 (ø mm 120 – Capacity / Capacità: 0,5 litre)

215/3 (ø mm 140 – Capacity / Capacità: 0,8 litre)

Mixing bowls for plaster and alginates
Tazze per alginato e gesso



WASTE CONTAINER, ALUMINIUM
CONTENITORE PORTA RIFIUTI, ALLUMINIO

ø 70 × 75 mm



975/G
Silver / Argento



975/D
Yellow / Giallo



975/R
Red / Rosso



975/V
Green / Verde



975/B
Blue / Blu

COTTON DISPENSER, ALUMINIUM
DISTRIBUTORE DI COTONE, ALLUMINIO

ø 55 × 75 mm



974/G
Silver / Argento



974/D
Yellow / Giallo



974/R
Red / Rosso



974/V
Green / Verde



974/B
Blue / Blu



6161/A (Silver / Argento)
6161/W (White / Bianco)
6161/B (Blue / Blu)
mm 85 × 85 × 360
Drinking cup dispenser
Distributore di bicchieri



6162
mm 45 × 45 × 50
Cotton pellet dispenser
Distributore di palline di cotone



ACCESSORIES / ACCESSORI

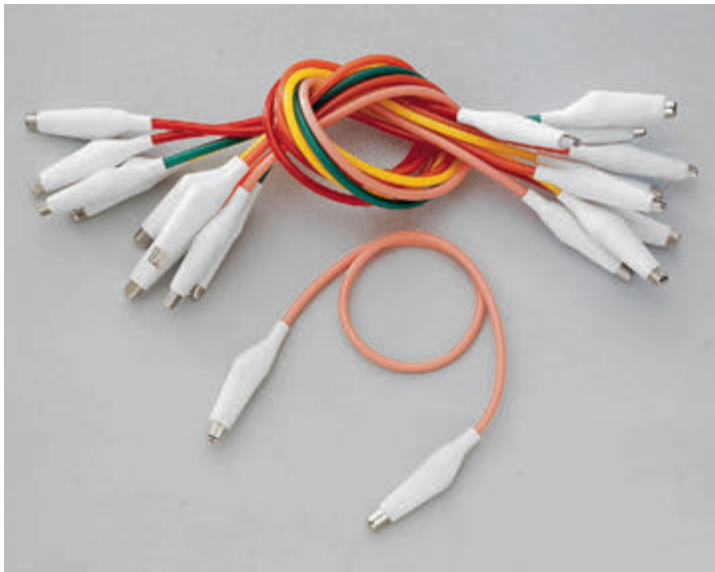

6210

Napkin holder, 10 pcs
Catenelle appendi bavagli, 10 pz



MEDESYS disposable saliva ejectors made in PVC atoxic, with metal wire, rounded cap for a perfect aspiration, flexible. Transparent plastic bags of 100/each and cartons of 1000/each.

Aspirasaliva monouso MEDESYS, in PVC non tossico, con filo metallico incorporato, cappuccio arrotondato per una perfetta aspirazione, flessibile. Imballati in sacchetti trasparenti da 100/pz. e cartoni da 1000/pz.

6100/15 (Neutral / Trasparenti)

6100/15 Blu (Blue / Blu)

6100/15 Verdi (Green / Verdi)



220

Tweezers porte films
Pinzette porta lastrine inox



6163

Alcohol burner
Lampada ad alcool

6163/S

Spare wick
Stoppino di ricambio



2821

Protesis carrier, assorted colors
Portaprotesi in plastica, colori assortiti



8400

Mayo instrument table for practice and operating room.

Table's dimensions: mm 630 × 450 × 25 h

Table's elevation: mm 900 to mm 1250

Tavolo di Mayo, per studio e sala operatoria.

Dimensioni del tavolo: mm 630 × 450 × 25 h

Elevazione del tavolo: mm 900 a mm 1250

LUBRICANT OIL WITH SPECIAL THIN DISPENSER NOZZLE

Lubricant oil: when used regularly it protects reliably from wear and prolongs the efficiency of the instrument.

The lubricant oil ensures that all hinged and jointed instruments keep operating smoothly and delicately and also protects them from corrosion and residues.

It is advisable to use the oil prior to sterilization procedures. Physically inert.

OLIO LUBRIFICANTE CON SPECIALE EROGATORE SOTTILE

Olio lubrificante: se usato regolarmente prolunga la durata e l'efficienza dello strumento.

L'olio lubrificante di Medesy favorisce il movimento scorrevole e delicato degli strumenti a snodo, proteggendo al tempo stesso da corrosione e sedimenti.

Si raccomanda di utilizzarlo antecedentemente la fase di sterilizzazione; è fisicamente inerte.



4155

12 ml

Tip length 7 mm

Lunghezza punta 7 mm



4160

12 ml

Tip length 40 mm

Lunghezza punta 40 mm





3161
mm 90
Cuticle scissors
Forbici per pelli



3164
mm 90
Cuticle scissors
Forbici per pelli



3187
mm 90
Nail scissors baby
Forbici per unghie bimbo



3175/R
mm 78
Tweezer straight
Pinzetta retta



3175/O
mm 78
Tweezer slant
Pinzetta obliqua



3162
mm 90
Nail scissors
Forbici per unghie



3163
mm 95
Nail scissors
Forbici per unghie



3188
mm 95
Nose scissors
Forbici per naso



3190
mm 98
Tweezer straight
Pinzetta retta



3191
mm 98
Tweezer slant
Pinzetta obliqua



3180
mm 140
Nail nipper
Tronchese per unghie



3182
mm 120
Nail nipper
Tronchese per unghie



3184
mm 100
Cuticle nipper
Tronchese per pellicine



3192
mm 150
Nail file
Limetta per unghie



100
mm 115

101
mm 165

Stork scissors
Forbici cicogna



Your hands are the best instruments in your practice. Take care of them with Medesy manicure set.

Le tue mani sono i più importanti strumenti per il tuo lavoro. Tienile curate con il set di manicure Medesy.



304/D

Gold plated, genuine leather
Dorato, astuccio in pelle



304/T

Nickel
Nichelato



New display case divided into 4 different sections (trays) which can be used to arrange instruments of various type. Each section (tray) has Velcro strips on the rear side and therefore the sections are interchangeable and you can combine the case according to each specific need. With this new system, you can remove from the case just and exactly the single tray you need.

Nuova valigetta, dispone di 4 singole sezioni (vassoi) che possono essere composte con strumenti assortiti. Ogni singola sezione (vassoio) ha delle strisce di velcro nella parte posteriore, rendendole intercambiabili e combinabili secondo preferenza.

Con questo nuovo sistema si possono comporre le valigette sulla base delle singole esigenze.



2918



Compose your own case!
Componi la tua valigetta!

2918/1

Elastics 10 pos.
Elastici 10 pos.



2918/2

Hand instruments 16 pos.
Strumenti manuali 16 pos.



2918/3

Extraction 6 pos.
Estrazione 6 pos.



New trolley, the optimal solution for exhibitions and presentations as it can contain a large number of instruments assorted in several trays. Available as an empty case or including a standard selection of Medesy instruments or even customized with your specific choice of products. On wheel casters the trolley can be easily transported.

Nuovo trolley per esposizioni e fiere di Medesy: un'ottima soluzione per portare numerosi strumenti in modo pratico e sicuro. Grazie alle rotelle in dotazione, il trolley si può trasportare agevolmente. Può essere fornito vuoto o in configurazione standard con articoli selezionati da Medesy o personalizzata su richiesta del cliente.



2915

2915 (With or without instruments)
2915 (Con o senza strumenti)



“ MEDESY IN SPOT
*Content can be changed
upon request*

*Su richiesta il contenuto
può essere cambiato* ”



7060

Specifications / Specifiche

Capacity / Capacità: 6 litre

Internal dimensions / Dimensioni interne: 300 × 230 × 100 (h) mm

Power ultrasonic / Potenza ultrasuoni: 200/400 W – 38 KHz

7120

Specifications / Specifiche

Capacity / Capacità: 12 litre

Internal dimensions / Dimensioni interne: 300 × 230 × 200 (h) mm

Power ultrasonic / Potenza ultrasuoni: 250/500 W – 38 KHz

ATTENTION!

- Check volts and plugs
 - Check standards required (CE-UL)
- before order!**



Our new ultrasonic baths are available in two tank sizes: 6 and 12 litres. Extremely compact and easily operated, these ultrasonic baths provide a high standard cleansing of surgical and dental instrumentation. Made of stainless steel this product stands out for its solidity and use safety. Equipped with microprocessor control for precision cleansing time and temperature controlled operation, the digital control panel displays accurately also power and frequency of the ultrasounds. Ultrasonic cleaning involves the use of high-frequency sound waves and is considered the most efficient system nowadays as it guarantees the full and accurate removal of all dirt residuals even inside the joints of the surgical instruments (such as needle-holders, pliers and scissors) and it reduces the risk of cutting injuries which may occur during manual cleansing. The optimal performance and longer duration of an instrument depends also on the adopted cleaning procedures.

Nuove vasche per lavaggio ad ultrasuoni, disponibili in 2 varianti: 6 o 12 litri. Estremamente compatte e facili da utilizzare, garantiscono il perfetto lavaggio dello strumentario chirurgico ed odontoiatrico. Sono prodotte in acciaio inossidabile e si contraddistinguono per solidità e sicurezza d'uso. Fornite di regolazione digitale della temperatura e dei tempi di lavaggio, sono dotate anche di display digitale dove si evidenzia la potenza e la frequenza degli ultrasuoni. Il lavaggio ad ultrasuoni è il sistema più efficace: garantisce infatti la pulizia anche all'interno degli snodi degli strumenti (come porta aghi, pinze e forbici) e riduce il rischio di tagli causati da una pulizia manuale. Un perfetto lavaggio contribuisce alla buona funzionalità e durata nel tempo degli strumenti.

